



HANDBOOK
SOLENOID VALVES

Ed. 2017

 **Castel**[®]
Italian technology

CHAPTER 9 ■ STANDARD COILS AND CONNECTORS



APPLICATION

For the NC (normally-closed) solenoid valves presented in Chapters 1, 2, 3, 6, and 7, Castel provides its customers with the following new series of coils that use the “FAST LOCK” system:

- **Series 9300** (coil type HF2), interchangeable with coils in series 9100 (coils type HM2) that are out of production. The coils in series 9300 can be used on all NC solenoid valves produced by Castel that used the coils in series 9100.
- **Series 9320** (coils type HF3) are interchangeable with coils in series 9120 (coils type HM3), that are still in production in direct current and rectified versions. The coils in series 9320 can be used on all NC solenoid valves produced by Castel that used the coils in series 9120.

The new “FAST LOCK” system (protected by law) guarantees secure fixing, without errors or carelessness, of the coil on the valve, making assembly and disassembly easy and quick. Coils using the “FAST LOCK” system can be assembled on valves, and later disassembled, without the need of additional equipment.

N.B.: the coils equipped with the “FAST LOCK” system cannot be assembled on the normally-open valves produced by Castel.

Furthermore, with regard to the NC (normally-closed) solenoid valves in Chapters 1, 2, 3, 6, and 7, the following types of coils are still available:

- **Series 9110** (coils type CM2)
- **Series 9120** (coils type HM3)
- **Series 9160** (coils type HM4)

For NO (normally-open) solenoid valves shown in Chapter 4, the choice must fall on the direct current coils in series 9120. For NO solenoid valves with a power supply of 220 VAC, Castel has developed a dedicated 220 V rectified coil (part number 9120/RD6).

Coils in series 9110, 9120, 9300, and 9320 can be coupled with all connectors in series 9150 and 9900 manufactured

by Castel. With the exception of connector 9155/R01, the protection rating guaranteed by the coil + connector system is IP65 according to the EN 60529 standard.

Coils in series 9160 must be used preferably with connector type 9155/R01. The protection rating of the coil + connector 9155/R01 system is IP65/IP68 according to the EN 60529 standard. Alternatively, these coils can be coupled with connectors in series 9150 or 9900. In this case, the protection rating of these systems is IP65.

The coil code 9120/RD6 must be coupled only with connectors/rectifiers codes 9150/R45 or 9150/R90. The protection rating guaranteed by the coil + connector system is IP65 according to the EN 60529 standard.

CONSTRUCTION

In compliance with IEC standard 85, the coils in series 9110, 9120, 9160, and 9320 have Class F encapsulation, while the coils in series 9300 have Class H encapsulation, and their production is compliant with standards EN 60730-1 and EN 60730-2-8. The windings are made of copper wire, with insulation class H (180 °C), in compliance with IEC standard 85. The outer casing is made of waterproof, dielectric resins that guarantee reinforced insulation and allow any type of assembly.

All coils have Class I protection ratings against electric contacts. Consequently, their safety requires an efficient ground system. Rubber gaskets assembled on the upper and lower ends of the coils (only on the lower end for coils in series 9300 and 9320) complete the protection of the windings from humidity.

The terminals of the coils in series 9120, 9160, 9300, and 9320 consist of two Faston connectors plus a Faston ground connector. Coils in series 9110 are equipped with an encapsulated co-moulded cable 1 m long. All coils in this chapter are designed for continuous use. The solid construction of these coils makes them suitable for use in refrigeration systems operating in heavy-duty environments

APPROVALS

Coils in series 9300 with 110 VAC, 220/230 VAC and 240 VAC power supply are approved by the German registration body, VDE. Coils in series 9110, 9160, and 9300 with 110 VAC, 220/230 VAC and 240 VAC power supply, and coils in series 9120 and 9320 with 220/230 VAC power supply are manufactured according to the Low Voltage (LV) Directive (2006/95/EC). All coils in this chapter comply with the Electromagnetic Compatibility (EMC) Directive (2004/108/EC).

CONNECTORS

DIN 43650 standardized connectors 9150 represent an effective system for the connection of the coil to the power system, thus ensuring safety also in the presence of moisture. Based on the assembly requirements, these connectors allow you to choose the orientation of the outer casing with respect to the inner terminal block. The gland nut of the outer casing is suitable for receiving cables with an external diameter of 6 to 9 mm and is equipped with a self-locking device. Three-pole cables with a cross-section greater than or equal to 0.75 mm² are recommended.

The connectors in series 9900 are available with co-moulded cables of different lengths. In these versions, the orientation of the casing cannot be changed with respect to the terminal block.

As long as they are used with the gaskets provided, both types ensure IP65 protection rating according to EN 60529.

Castel developed specific connectors, series 9155, suitable for use in refrigeration systems operating in heavy-duty environments, for example:

- exposure to the atmospheric conditions
- rooms with high degree of moisture
- cyclic condensing / evaporation on the valve
- cyclic icing / defrosting on the valve

Based on the assembly requirements, these connectors allow you to choose the side orientation of the outer casing with respect to the inner terminal block. It is not possible to point the exit of the cable upwards. The gland nut of the outer casing is suitable for receiving cables with an external diameter of 6 to 9 mm and is equipped with a self-locking device. It is again recommended that three-pole cables with a cross-section greater than or equal to 0.75 mm² be used. As long as they are used with the gaskets provided, the connectors in series 9155 ensure IP65/IP68 protection rating according to the EN 60529 standard.

Connectors 9150/R45 and 9150/R90 are equipped with a full-wave bridge rectifier plus VDR for protection. Connector 9150/R90 is the version with a 2 m long, co-moulded cable, with remote rectified circuit (with respect to the connector). The VDR (Voltage e-Dependent-Resistor) device is a special type of resistor, mounted in parallel to the windings. Its purpose is to protect the diodes and the coil from any voltage surges generated within the alternating current supply circuit.

WARNING: connectors 9150/R45 and 9150/R90 must be used only with coil 9120/RD6 (220 V RAC). Incorrect use of these connectors with other types of Castel coils leads to the rapid destruction of the coil.

TABLE 30: General characteristics of coils

Catalogue Number	Coil Type	Voltage [V]	Voltage tolerance [%]	Frequency [Hz]	Insulation class EN 60730	TA [°C]		Connection	Connectors	Protection Degree
						min.	max.			
9110/RA2	CM2	24 A.C.	+10 / -10	50 / 60	H	-20	+50	Three wires cable	-	IP 66
9110/RA4		110 A.C.								
9110/RA6		220/230 A.C.	+6 / -10							
9110/RA7		240 A.C.								
9120/RD1	HM3	12 D.C.	+10 / -5	-	F	-20	+50	Terminal block for DIN 43650/A	9150/R02 9900/X##	IP 65 (with connector)
9120/RD2		24 D.C.								
9120/RD3		27 D.C.								
9120/RD4		48 D.C.								
9120/RD6		220 RAC								
9160/RA2	HM4	24 A.C.	+10 / -10	50 / 60	F	-20	+50	Terminal block for DIN 43650/A	9150/R02 9155/R01 9155/R02 9900/X##	IP 65 (with connectors 9150 , 9900)
9160/RA4		110 A.C.								
9160/RA6		220/230 A.C.	+6 / -10							
9160/RA7		240 A.C.								
9300/RA2	HF2	24 A.C.	+10 / -10	50 / 60	H	-20	+50	Terminal block for DIN 43650/A	9150/R## 9900/X##	IP 65 (with connector)
9300/RA4		110 A.C.								
9300/RA6		220/230 A.C.	+6 / -10							
9300/RA7		240 A.C.								
9300/RA8		380 A.C.								
9320/RA6	HF3	220/230 A.C.	+6 / -10	50 / 60	F	-20	+50	Terminal block for DIN 43650/A	9150/R02 9900/X##	IP 65 (with connector)
9320/RD1		12 D.C.								
9320/RD2		24 D.C.								
9320/RD4		48 D.C.								
9320/RD6		220 RAC								

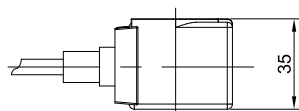

9110 (Type CM2)

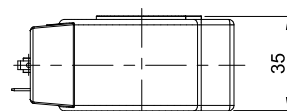

9120 (Type HM3)

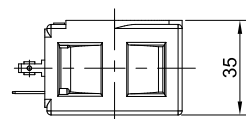
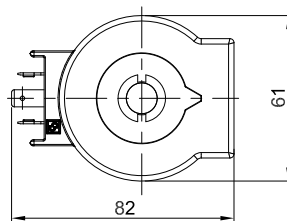
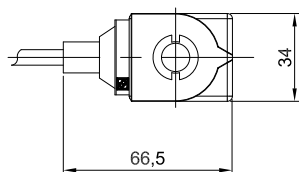

9160 (Type HM4)

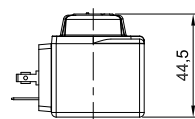

9300 (Type HF2)

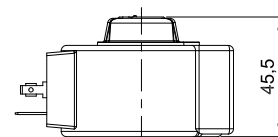
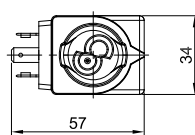
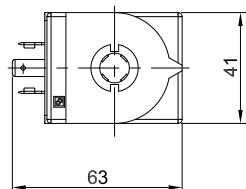

9320 (Type HF3)

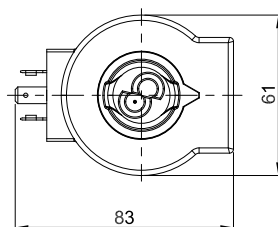
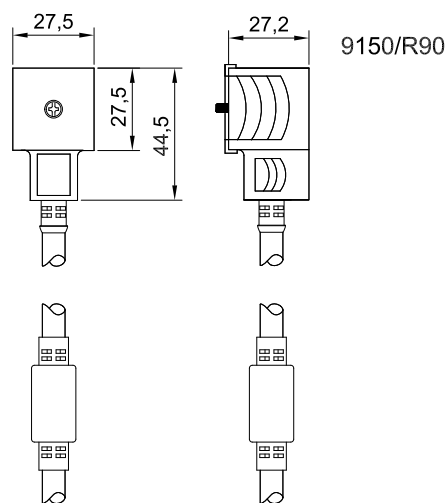
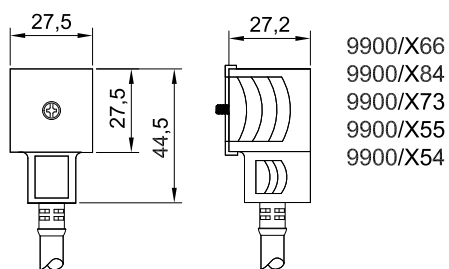
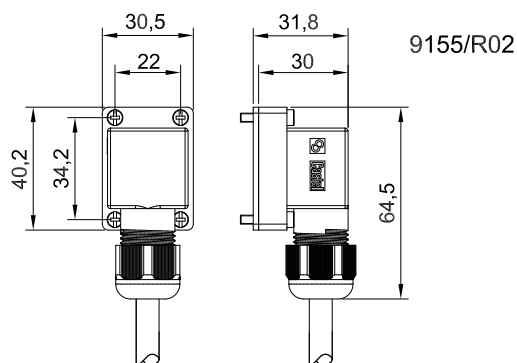
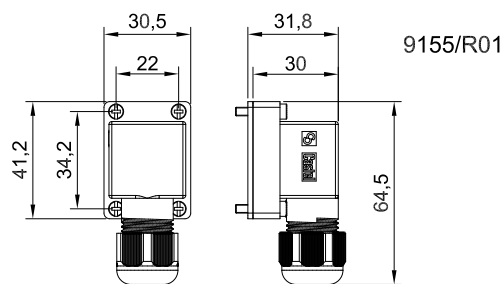
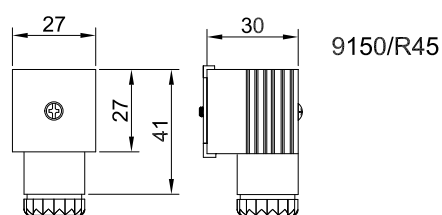
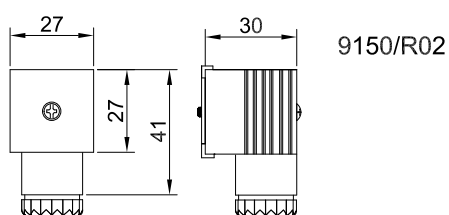

TABLE 31: Coils consumptions and weights

Catalogue Number	Coil Type	Voltage [V]	Power [W]	Consumption at 20 °C [mA]						Weight [g]			
				Start			Working						
				50 [Hz]	60 [Hz]	D.C.	50 [Hz]	60 [Hz]	D.C.				
9110/RA2	CM2	24 A.C.	8	920	825	-	527	420	-	230			
9110/RA4		110 A.C.		230	205		128	114					
9110/RA6		220/230 A.C.		120	105		68	58					
9110/RA7		240 A.C.		100	87		54	43					
9120/RD1	HM3	12 D.C.	20	-	-	-	-	-	-	470			
9120/RD2		24 D.C.									20	1720	895
9120/RD3		27 D.C.									20	800	800
9120/RD4		48 D.C.									22	460	460
9120/RD6		220 RAC									18	93	93
9160/RA2	HM4	24 A.C.	8	1490	1320	-	700	530	-	220			
9160/RA4		110 A.C.		330	300		156	118					
9160/RA6		220/230 A.C.		162	142		76	57					
9160/RA7		240 A.C.		147	130		70	53					
9300/RA2	HF2	24 A.C.	8	920	825	-	527	420	-	180			
9300/RA4		110 A.C.		230	205		128	114					
9300/RA6		220/230 A.C.		140	128		68	58					
9300/RA7		240 A.C.		100	87		54	43					
9300/RA8		380 A.C.		58	51		32	23					
9320/RA6	HF3	220/230 A.C.	12	190	160	-	110	80	-	500			
9320/RD1		12 D.C.	20	-	-	-	-	-	1720				
9320/RD2		24 D.C.	20						895				
9320/RD4		48 D.C.	22						460		460		
9320/RD6		220 RAC	18						93		93		

TABLE 32: General characteristics of connectors

Catalogue Number	Supply Voltage [V]		Cable length [m]	Cable thickness [mm ²]	Standard	Degree of protection	Class of insulation
	Nominal	Maximum					
9150/R02	-	-	-	-	DIN 43650	IP65 EN 60529	Group C VDE 0110-1 / 89
9150/R45	220 A.C.	250 A.C.					
9150/R90	220 A.C.	250 A.C.	2	3 x 0,75			
9900/X66	-	-	1	3 x 0,75			
9900/X84			1,5				
9900/X73			2				
9900/X55			3				
9900/X54			5				
9155/R01	-	-	-	-			
9155/R02	-	-	1	3 x 0,75			



www.castel.it



ed. 001-VS-ENG

Castel can accept no responsibility for any errors or changes in the catalogues, handbooks, brochures and other printed material. Castel reserves the right to make changes and improvements to its products without notice. All trademarks mentioned are the property of their respective owners. The name and Castel logotype are registered trademarks of Castel Srl. All rights reserved.

Castel Srl - Via Provinciale 2-4 - 20060 Pessano con Bornago - MI